

We assume a guarantee – according to our manufacturer guarantee statement – of 5 years for our products, provided that it can be demonstrated that the product was purchased and mounted through a franchised specialist craftsman. The guarantee period begins on the date of delivery from our plant. The statutory warranty period is contained in the guarantee period. Electronic components and lighting articles are omitted from this guarantee statement.

Even the most advanced printing technologies cannot fully reproduce the exceptional finish and subtle colour schemes of our products. Only original KEUCO products can provide you with an optimum impression. These are on display in stores catering to the special sanitary trade.

No part of this brochure may be reprinted or duplicated, even in part, without our explicit consent and without specification of the source manufacturer.  
KEUCO GmbH & Co. KG,  
Postfach 1365, D-58653 Hemer

We accept no liability for changes resulting from technical advances and necessary modifications of design and colour, nor from print errors.

Our products are exclusively available through sanitary product wholesalers.

Concept, text, design,  
and lithography:  
Kontrast Communication  
Services GmbH, Düsseldorf  
Setting/product photography:  
Studio CASA, Münster  
Printing:  
Meinders & Elstermann  
GmbH & Co. KG,  
Belm (Osnabrück)  
Printed on GALAXI Keramik.  
Supplied by the Papier Union.

## FITTINGS AND ACCESSORIES

<b>TABLE OF CONTENTS</b>	<b>3</b>
<b>FOREWORD</b>	<b>4-5</b>
<b>BATHROOM – FITTINGS &amp; ACCESSORIES</b>	<b>6-39</b>
PLAN	6-13
ELEGANCE	14-21
EDITION 300	22-27
EDITION Palais	28-33
EDITION Atelier	34-39
<b>BATHROOM – ACCESSORIES</b>	<b>40-63</b>
ALEA	42-43
AMARO	44-45
ASTOR	46-47
CITY.2	48-49
CLEO	50-51
EDITION 200	52-53

## Table of Contents

SOLO	54-55
Universal articles	56-57
Soap baskets	58-59
Cosmetic mirrors	60-63
<b>GUEST BATHROOMS – FITTINGS &amp; ACCESSORIES</b>	<b>64-75</b>
ELEGANCE	66-67
EDITION 300	68-69
PLAN	70-71
JOLY	72-73
VISIT	74-75
<b>PRODUCT OVERVIEW</b>	<b>76-121</b>

“As market leader for high quality bathroom accessories, for over 50 years KEUCO has developed and produced quality products which are known for their lasting value, longevity and enduring design. The accessories and fittings of each individual collection are characterized by a consistent design, created by a renowned designer. Years of know-how, ongoing development, and state-of-the-art technologies guarantee the valuable quality, brilliant surfaces and excellent functionality of our brand-name products. The brand, KEUCO, stands for premium products, both in terms of technology as well as design; products which have been recognized and been in demand on the world market for years as ‘German craftsmanship’. KEUCO – our passion for your personal well-being in the bathroom.”

Hartmut Dalheimer, Managing Director/Engelbert Himrich, Managing Partner





PLAN



Handling the fittings is as pleasant to experience as the forms are pure. Whether with chrome, stainless steel or aluminium finish: The excellent design and the unmatched quality of PLAN fittings are remarkable in each individual item. Meticulous design, by the way, reveals itself sometimes very inconspicuously: For example, through ease of cleaning.

Product overview, see pages 84 – 85



PLAN goes along with all of your plans. After all, it is the most comprehensive bathroom furnishing concept on the market. Together with the surface variations, this variety is multiplied even more: Choose from chrome, aluminium and stainless steel. Below, heavy-quality lotion dispensers; on the right, handles, towel and toilet paper holders.

Product overview, see pages 76 – 83



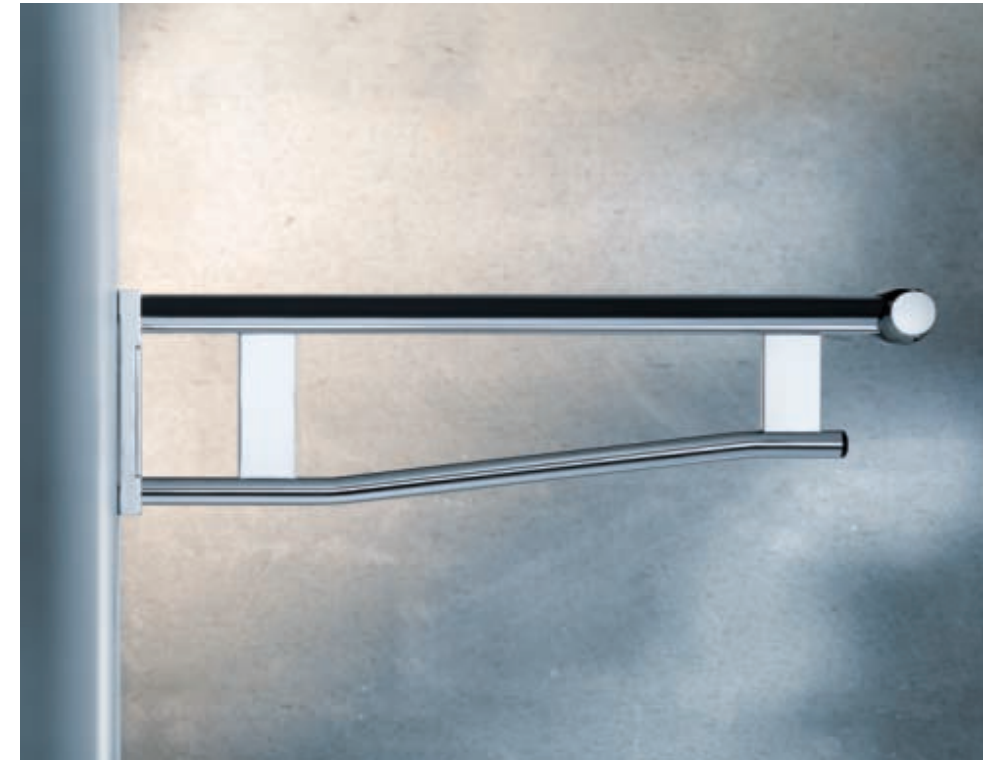

PLAN products are extremely long lasting. And because expectations of comfort increase with age, a PLAN bathroom can be adapted in this respect over the course of time: on the left a shower setting with folding seat, above right a wall support handle for the WC. Underneath, with uncomplicated elegance, a towel hook and tumbler holder with crystal glass tumbler.

**Product overview, see pages 76 – 83**



ELEGANCE



Right angles and straight lines coupled with sweeping curves. ELEGANCE convinces with its expressive, classic-modern design. On the left, towel rail and sponge wire basket with hygienic, removable plastic insert; on the right the single-lever basin mixer – it includes intelligent ergonomics and is very cleaning-friendly.

Product overview, see pages 86 – 91

ELEGANCE



Possible solutions à la carte: Even the shower units can be flexibly adapted to your wishes. Because, the great variety allows unrestricted design options. And that is always a part of ELEGANCE.

Product overview, see pages 89 – 91

ELEGANCE

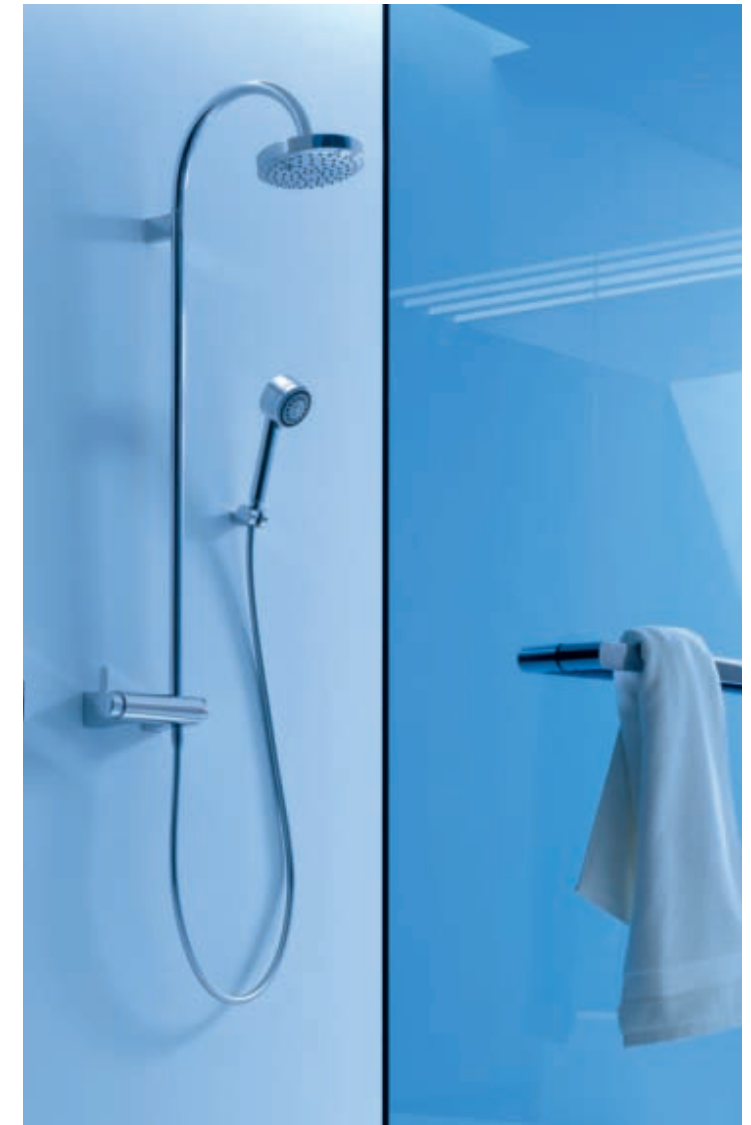



The comprehensive ELEGANCE assortment ranges right to the chrome-plated bidet fitting. To the right the closed paper holder, below a WC set with chrome-plated lid and convenient operation.

Product overview, see pages 86 – 87





EDITION 300



The rich variety of EDITION 300 fittings allows generous planning freedom. Shower mixers are available, for example, as on wall or in wall mounting model, as single lever mixer or thermostat mixer. Below are the free standing washbasin fittings. Concealed from sight, but all the more useful: the inner ceramic cartridge with temperature limiter.

**Product overview, see pages 93 – 95**

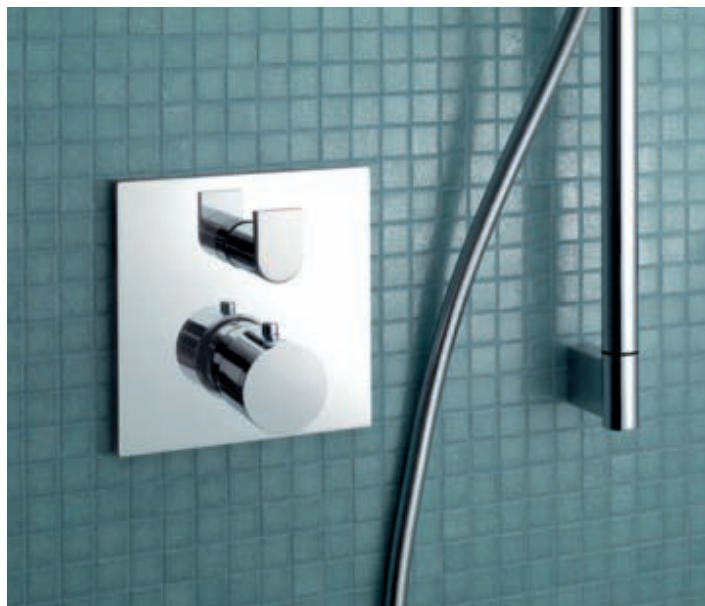



EDITION 300 design is expressed in the accessories in its own unique way. With beautiful symmetry, circular edges and straight lines combine into simple, highly functional forms.

Product overview, see page 92





EDITION Palais



EDITION Palais borders the exciting area where classic elegance and modern minimalism meet. This is demonstrated plainly also by the fittings and accessories. Typical KEUCO: The fittings are available in many variations for all possible wash-basins, shower and bath settings. A choice is also available for the surfaces: either chrome or palladium silver, which was developed by our own electroplating department and has a slightly gold-like metal shine.

**Product overview, see pages 96 – 97**







Light reflections trace out the characteristic profile of EDITION Palais. Clockwise: Towel holder and ring, wall holder with white porcelain tumbler, soap holder with white porcelain dish.

**Product overview, see pages 96 – 97**



EDITION Atelier



Straight lines, right angles and circles: Out of simple basic forms, EDITION Atelier creates its own aesthetic quality. Its functional clarity characterises also the fittings and accessories. The accented tubular form of the fittings creates a special effect. Left a shower unit and towel holder, on the right the free standing bath tub mixer.

**Product overview, see page 99**



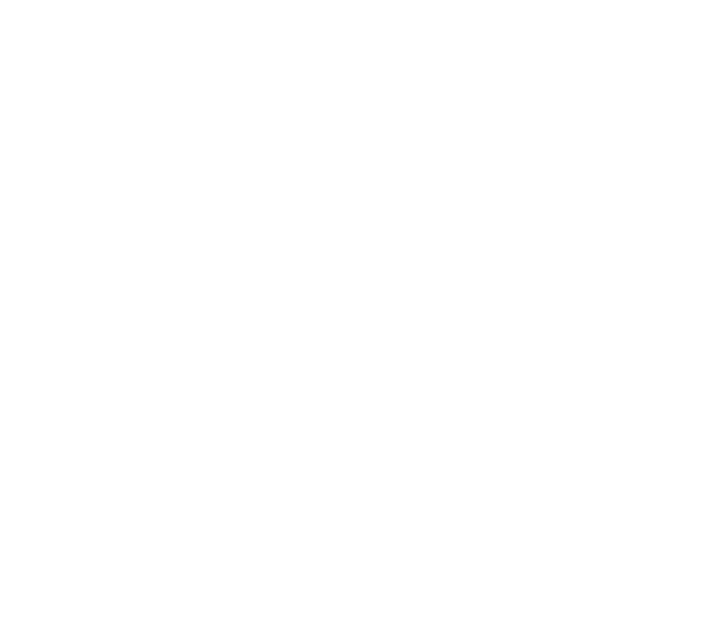

EDITION Atelier blurs the boundaries between separate living spaces. Even the accessories of the edition facilitate a flowing transition to the bedroom: chrome-plated floor lamp with chintz shade and side table with porcelain top (at the very left and the right very respectively). In the middle: heavy, four-part stacking accessories to store small utensils. Toilet paper double holder, toilet brush set and foam-soap dispenser.

**Product overview, see page 98**



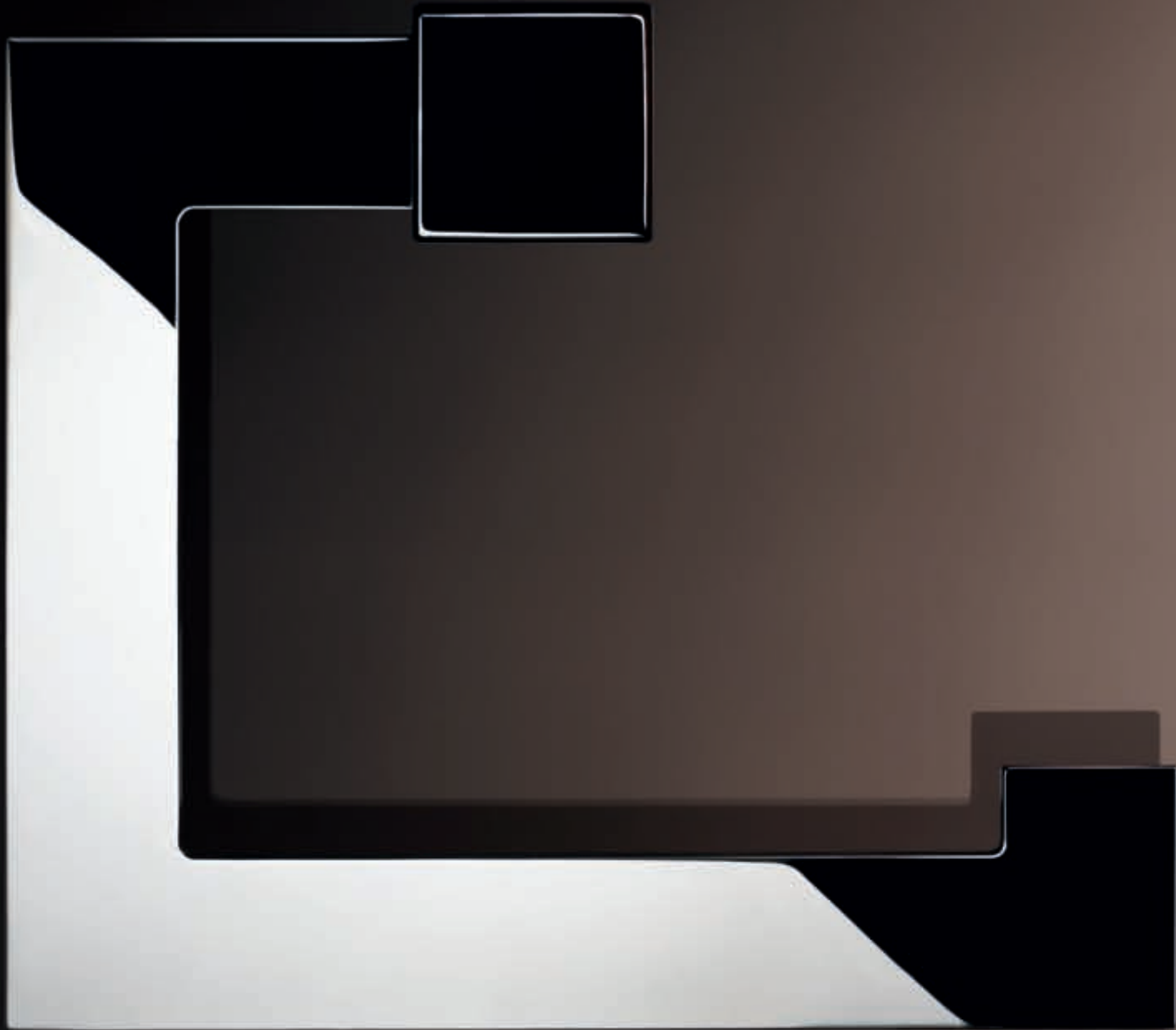

Accessories

The striking foundation of ALEA is the metal cube of the wall mounting. Coupled with flowing forms and flat metal bands, the design generates a light, modern feeling. Below the soap holder, on the right a towel hook, towel ring and the tumbler holder with frosted crystal glass tumbler.

Product overview, see pages 100–101



AMARO is a comprehensive accessories series whose character emanates from the playful use of round forms. On the right the lotion dispenser in the spiral shaped holder. On this page: soap holder with crystal glass dish, towel ring and universal shelf with rail and crystalline glass plate.

Product overview, see pages 102 – 103





Elegance out of circular and ball forms: With its collar covers, ASTOR accessories shine in the bathroom with an aristocratic flair. Left the chrome-plated towel ring. Right: lotion dispenser made of frosted opal glass, soap holder with crystal glass dish, tumbler holder with crystal glass tumbler and toilet paper holder with cover.

**Product overview, see pages 104 – 105**





Urban style with an unbeatable price-performance ratio: CITY.2 brings an objective elegance into the bathroom. The series satisfies a wide range of needs, thanks to the large variety of products. On the right the lotion dispenser, on this page the soap holder and towel ring.

**Product overview, see pages 106 – 107**





The internationally renowned Italian architect and designer Matteo Thun created the KEUCO series CLEO. He was inspired by the movement of water whose vibrant dynamism he carried over into the accessories – clearly seen in the towel ring on the left. On the right a toilet brush set, above that the soap holder fashioned from one piece out of metal, and the lotion dispenser made of frosted opal glass.

**Product overview, see pages 108 – 109**



The perfectly crafted accessories of EDITION 200 are not only attractive to look at, they also satisfy the most stringent demands on ergonomics and longevity. On the left shimmers the lotion dispenser made of frosted opal glass. Above: soap dish and towel ring, both chrome-plated.

**Product overview, see pages 110 – 111**



Despite its name, the SOLO collection is a mature series with a wide range of products. At the most, the only feature it has where it stands alone is its attractive price-performance ratio. Quartet including soap holder, toilet paper holder, double tumbler holder and towel ring.

**Product overview, see pages 112 – 113**





A universe of accessories: The universal articles satisfy every need, because they offer a suitable accessory for any situation. They are just as suitable for private use as for use in public facilities. Thanks to their functionally practical design and the different variations, they complement every kind of bathroom furnishing.

**Product overview, see pages 114 – 116**



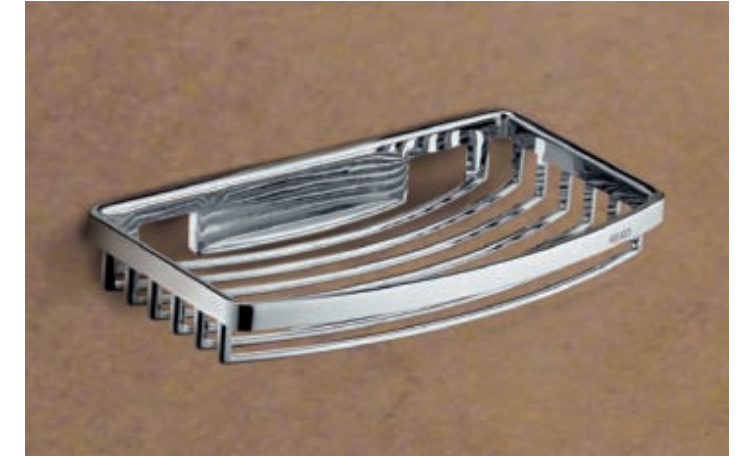
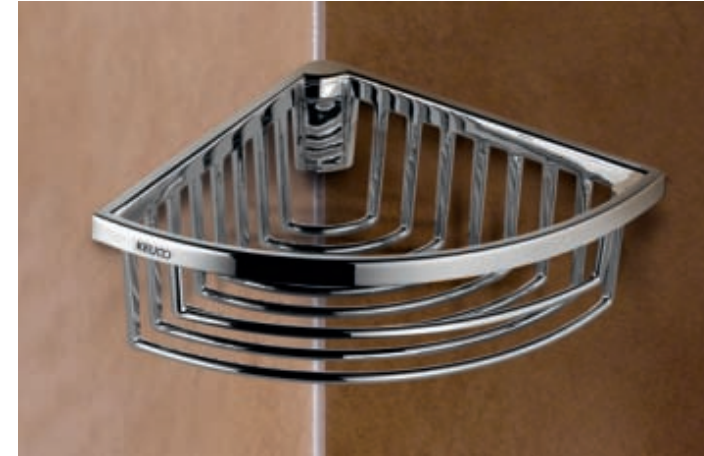
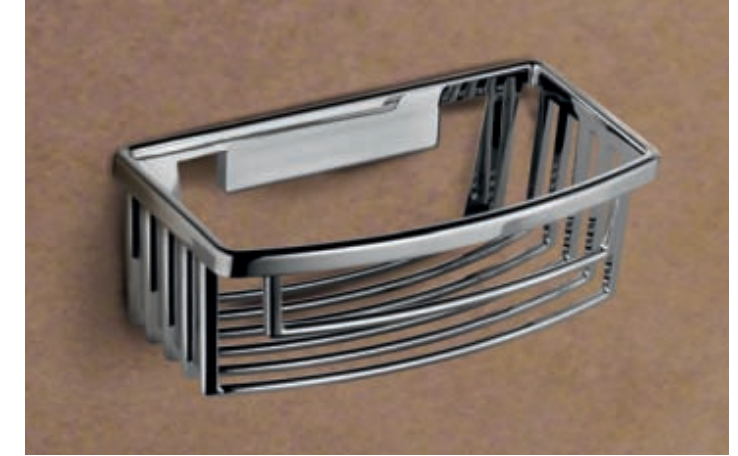
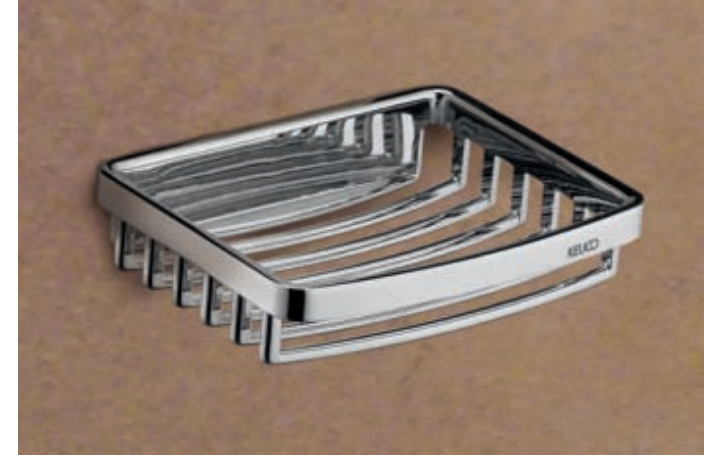

Properly designed shower accessories: Whether mounted in the corner or on the wall, whether with high rail or low, whether wide or thin – everything that foams has a suitable place thanks to the rich assortment of KEUCO soap baskets.

**Product overview, see pages 116 – 117**



The BELLA VISTA also illuminates without glare, but doesn't fit in the handbag because of its generous size. It makes up for that with its flexibility: It features a flexarm and is available in variations with direct mains connection, mains adapter or as standing model.

**Product overview, see pages 118 – 119**



The iLook has the potential to become your permanent companion because it isn't just practical in the bathroom but also in every handbag. Its battery operated, glare free LED light conducting technology and the distortion free optics meet even professional requirements. The iLook offers many set-up variations and if desired it is also available with wall mounting rod and additional mains adapter.

**Product overview, see pages 118 – 119**



You will surely take a second look: cosmetic mirrors in all variations. Illuminated or not, standing models, wall mounted models, various sizes and with various adjustment possibilities. In the end, not only your bathroom should look good, but you as well.

**Product overview, see pages 118 – 119**





GUEST BATHROOMS



With ELEGANCE, we have thought of everything – even your guests: For the smaller cloakroom there is a light mirror and wash-basin in size S. Right: The foamed soap dispenser supplies a fine mousse – this has a luxurious feel and is also economical with wash lotion. Bottom right: Just as with the larger models, the small sink base unit also offers much room for storage behind its hinged door.

**Product overview, see pages 86 – 91**





The guest bathroom is a special calling card in every house. EDITION 300, with its high degree of functionality and stylistic elegance, is especially apt at leaving an excellent impression on your guests. With the compact, minimally projecting washbasin dimensions, it is possible to design even guest bathrooms generously with charm. The towel holder and vanity unit with its front drawer and integrated towel opening offer much comfort for small rooms.

Product overview, see pages 92 – 95





Overall, PLAN is the most comprehensive and changeable KEUCO collection. This can be appreciated in the guest WC. The number of variations with PLAN allows the most elegant of solutions for even the smallest of rooms. On top of that, new standards have been set for matters of functionality with the single lever mixer, the pillar tap and the sensor mixer.

**Product overview, see pages 76 – 85**





Asymmetrical forms and the unmistakable multi-purpose rails: The JOLY design concept demonstrates its adaptability during the planning phase. It can make a small guest WC into a virtual adornment.

**Product overview, see page 120**





Innovationspreis  
Architektur und Bauwesen

Behind the discrete elegance of glass and aluminium, VISIT presents surprisingly detailed solutions. The lotion dispenser is elegantly integrated in the panel of the light mirror. Spare WC paper and toilet brush find an unobtrusive spot in the wall box.

Product overview, see page 121



 surface chrome-plated
  surface aluminium silver anodized (E6 EV1) or aluminium finish
  surface stainless steel or stainless steel finish



**Towel rail**  
600, 800 mm



**Shelf**  
with crystalline glass shelf  
220 x 100 mm  
350 x 120 mm  
550 x 120 mm



**Towel hook**  
with door buffer, black

**Towel hook**



**Towel hook**

**Lotion dispenser**  
frosted crystal glass  
Capacity: approx. 250 ml



**Built in soap dispenser**  
for mounting on washbasin  
or washbasin worktop



**Foamed-soap dispenser**  
frosted opal glass  
Capacity: approx. 250 ml  
including starter materials  
foam-soap (2 x 500 ml)



**Towel rail**  
300 mm



**Towel hook panel**  
with 4 hooks



**Towel holder**  
two arms, swivelling  
Projection: 300, 455 mm

**Lotion dispenser**  
sensor-controlled,  
Capacity: approx. 0.8 l  
battery-operated, 4 batteries  
1.5 V AA required



**Lotion dispenser**  
Capacity: approx. 1.1 l



**Tumbler holder**  
with crystal glass tumbler



Product Overview



**Towel ring**  
large model

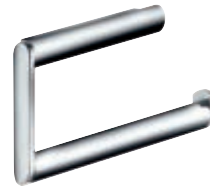

**Towel ring**  
small model



**Universal dish**  
with crystal glass plate  
210 x 115 mm



**Cosmetic mirror BELLA VISTA**  
Wall model, illuminated,  
optional with mains connection  
or helix cable and power plug,  
magnification factor x 3, 1 x 8 W LED  
Ø 218 mm

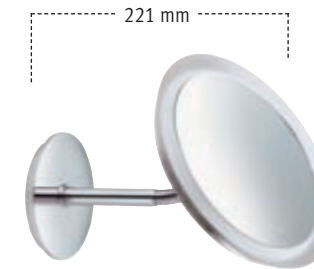

**Cosmetic mirror BELLA VISTA**  
Standing model, illuminated,  
with power lead (1.70 m),  
magnification factor x 3, 1 x 8 W LED  
Ø 218 mm



**Soap holder**  
with crystal glass dish



**Lotion dispenser, standing model**  
Capacity: approx. 250 ml





**Lotion dispenser, wall model**  
Capacity: approx. 250 ml



**Bathroom stool**  
also suitable for wet rooms

**Cosmetic mirror**  
with pivoting arm, non illuminated,  
adjustable in three dimensions,  
magnification factor x 2.5  
Ø 190 mm

-  surface chrome-plated
-  surface aluminium silver anodized (E6 EV1) or aluminium finish
-  surface stainless steel or stainless steel finish



Spare paper holder



Toilet paper holder with lid for 100/120 mm wide paper rolls



Toilet paper holder closed form, theft-proof, for 100/120 mm wide paper rolls

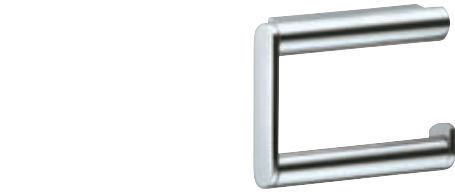

Toilet paper holder open form for 100/120 mm wide paper rolls

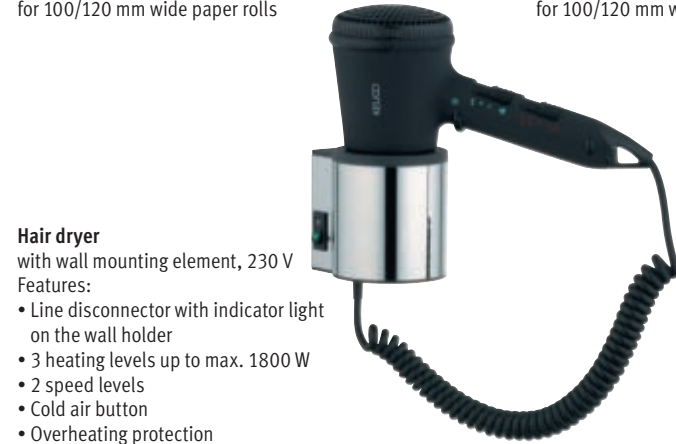

**Hair dryer**  
with wall mounting element, 230 V  
Features:  
• Line disconnecter with indicator light on the wall holder  
• 3 heating levels up to max. 1800 W  
• 2 speed levels  
• Cold air button  
• Overheating protection



**Ashtray**  
with fireproof ash dish, theft-proof



**Toilet brush set**  
with removable synthetic insert, brush and spare brush head



**Toilet brush set**  
with removable synthetic insert, brush and spare brush head



**Toilet brush set**  
complete with synthetic insert, brush with extended handle and spare brush head



**Wall light**  
with frosted opal glass and light bulbs (2 x 40 W E14)

Product Overview



**Sanitary waste bin**  
wall mounted  
Capacity: 3 l



**Waste bin**  
wall mounted  
Capacity: 30 l



**Paper towel dispenser**



**Pivoted supporting rail for wash basin**  
with synthetic covered support, to vertical position movable, braked version  
Projection: 650 mm



**Pivoted supporting rail for WC\***  
with synthetic covered support, to vertical position movable, braked version and removable toilet paper holder with rollbrake  
Projection: 700/850 mm



**Cover plate**  
for fastening holes for supporting rails and pivoted supporting rails



**Multiple toilet roll dispenser**  
for horizontal or vertical installation, can be mounted for 2 rolls of 100/120 mm in width

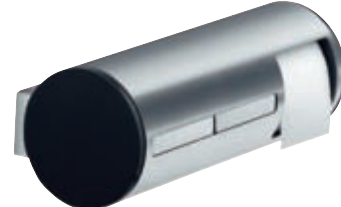

**Multiple toilet roll dispenser**  
for horizontal or vertical installation, can be mounted for 3 rolls of 100/120 mm in width



**Supporting rail for wash basin**  
firmly fastened, with synthetic covered support  
Projection: 450/650 mm

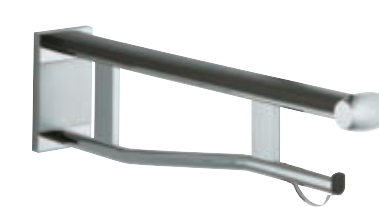

**Pivoted supporting rail for WC\***  
firmly fastened, with synthetic covered support and removable toilet paper holder with rollbrake  
Projection: 700/850 mm

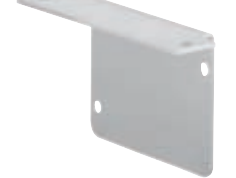

**Fastening angle bracket**  
for WC flushing mechanism Grohe/Dal (Art. No. 37559 000) for fastening to WC pivoted supporting rails

\*also available with integrated electronic remote-controlled flush system suitable for Geberit and Viega.





**Back rest**  
for use on WC,  
consists of wall rail  
(600 mm) and back rest  
in dark grey and light grey



**Tip-up seat**  
fo wall mounting, seat folds upwards,  
seat size 360 mm wide, seat surface in dark grey  
or light grey



**Tip-up seat with back rest**  
for wall mounting, seat folds upwards,  
seat size 360 mm wide, seat surface and back rest  
in dark grey or light grey



**Tip-up seat with back rest**  
for hanging in handles as well as shower  
and bath tub handles, seat folds upwards,  
seat size 360 mm wide, seat surface and back rest  
in dark grey and light grey

surface chrome-plated    surface aluminium silver anodized (E6 EV1) or aluminium finish

382 mm, 482 mm, 582 mm,  
682 mm, 782 mm, 882 mm,  
982 mm, 1082 mm, 1182 mm



**Towel rail**  
for horizontal or vertical installation  
300, 400, 500, 600, 700, 800, 900, 1000, 1100 mm



**Angle bar 135°**  
may be used on the left or right  
300/400 mm



**Angle bar 90°**  
may be used on the left or right  
300 x 600 mm

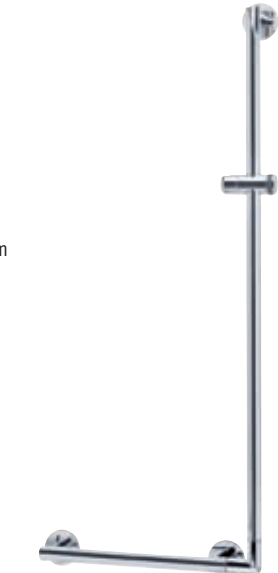

**Angle bar 90°**  
for use as shower rail  
complete with shower head bracket  
may be used on the left or right  
400 x 1100 mm



**Hand shower sliding rail**  
complete with shower  
bracket  
900, 1100 mm

Product Overview

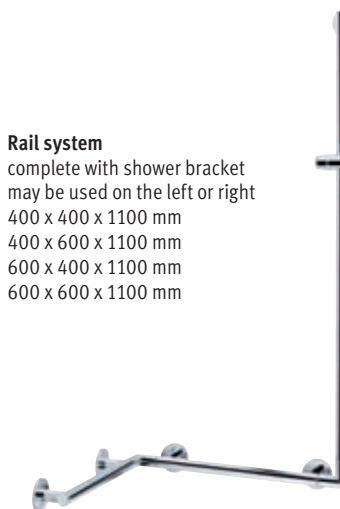

**Rail system**  
complete with shower bracket  
may be used on the left or right  
400 x 400 x 1100 mm  
400 x 600 x 1100 mm  
600 x 400 x 1100 mm  
600 x 600 x 1100 mm

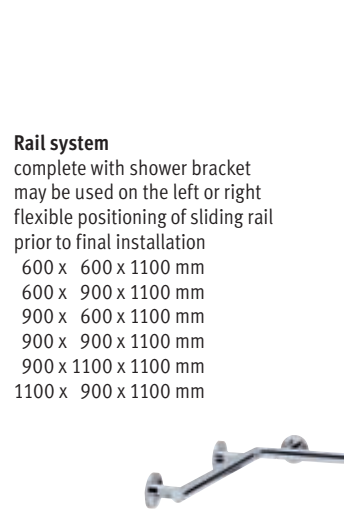

**Rail system**  
complete with shower bracket  
may be used on the left or right  
flexible positioning of sliding rail  
prior to final installation  
600 x 600 x 1100 mm  
600 x 900 x 1100 mm  
900 x 600 x 1100 mm  
900 x 900 x 1100 mm  
900 x 1100 x 1100 mm  
1100 x 900 x 1100 mm

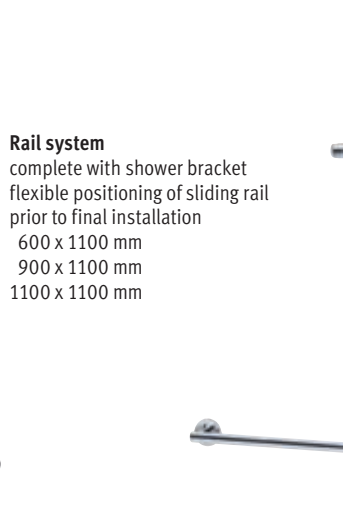

**Rail system**  
complete with shower bracket  
flexible positioning of sliding rail  
prior to final installation  
600 x 1100 mm  
900 x 1100 mm  
1100 x 1100 mm

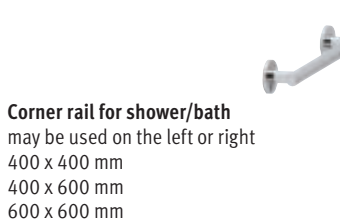

**Corner rail for shower/bath**  
may be used on the left or right  
400 x 400 mm  
400 x 600 mm  
600 x 600 mm



**Hand shower bracket**  
for shower rail, height adjustable



**Toilet paper holder**  
for mounting on an angle bar

Available shower curtain colours

white PLAN uni/PLAN maxxi    ecru PLAN uni    light grey PLAN uni    off-white PLAN Flame CS



**Shower curtain PLAN uni\***  
100% Trevira, 80g/m<sup>2</sup>, shower proof, fungicidal,  
anti-bacterial, anti-static, calendered, washable  
at 30 °C, can be disinfected at 60 °C (Shrinkage  
rate 1 – 2%), ironing possible (Shrinkage rate 3 – 5%),  
tested for harmful substances according to the  
Oeko-Tex Standard 100  
Full length: 1800, 2000 mm  
Width: 1400, 2000, 3000 mm  
Colours: white, ecru, light grey



**Shower curtain PLAN Flame CS\***  
highly flame resistant according to DIN 4102/B1  
100% Trevira, 80 g/m<sup>2</sup>, shower proof, fungicidal,  
anti-bacterial, anti-static, calendered, washable  
at 30 °C, can be disinfected at 60 °C (shrinkage  
rate 1 – 2%), ironing possible (shrinkage rate 3 – 5%),  
tested for harmful substances according to the  
Oeko-Tex Standard 100  
Full length: 1800, 2000 mm  
Width: 1400, 2000, 3000 mm  
Colour: off-white



**Shower curtain PLAN maxxi\***  
100% polyester, 75 g/m<sup>2</sup>, shower proof, fungicidal,  
anti-bacterial, washable at 30 °C (shrinkage rate 3%),  
ironing possible (shrinkage rate 3 – 5%), tested for  
harmful substances according to the  
Oeko-Tex Standard 100  
Full length: 1800, 2000 mm  
Width: 1800, 2000, 3000 mm  
Colour: white

**\*Notes on production characteristics:** Vertical seams, reinforced stainless steel eyelets, distance between the eyelets approx. 20 cm, roll hem stainless steel weighted, 50 g per metre, complete with curtain rings, white.  
**Notes on sizes:** The sizes indicated are the sizes of the finished curtain. To prevent the curtain from lying on the ground we recommend a distance from curtain to floor of approx. 30 mm. Distance between the middle of the curtain rod and the upper edge of the curtain approx. 40 mm. The width of the curtain should be approx. 1.3 to 1.5 times the length of the shower curtain rod.

Available shower curtain colours

- white  
PLAN uni/PLAN maxx
- ecru  
PLAN uni
- light grey  
PLAN uni
- off-white  
PLAN Flame CS



**\*Notes on production characteristics:** Vertical seams, reinforced stainless steel eyelets, distance between the eyelets approx. 20 cm, roll hem stainless steel weighted, 50 g per metre, complete with curtain rings, white.

**Notes on sizes:** The sizes indicated are the sizes of the finished curtain. To prevent the curtain from lying on the ground we recommend a distance from curtain to floor of approx. 30 mm. Distance between the middle of the curtain rod and the upper edge of the curtain approx. 40 mm. The width of the curtain should be approx. 1.3 to 1.5 times the length of the shower curtain rod.



**Spray guard**  
to be hooked on rail system or grab rails complete with shower curtain PLAN maxx (670 x 800 mm)



**Shower curtain rail**  
300 – 2000 mm



**Connecting tube**



**Tube angle piece 90°**  
for rectangular shower tray

**Connecting piece**  
in dark grey or chrome-plated



**Set of shower curtain rails**  
for rectangular shower tray 1000 x 1000 mm, consisting of:  
2 x wall mounting set  
2 x shower curtain rail 900 mm  
1 x tube angle piece 90° for rectangular shower tray  
2 x 10 shower curtain rings, white



**Set of shower curtain rails**  
for rectangular shower tray 1200 x 1200 mm, consisting of:  
2 x wall mounting set  
2 x shower curtain rail 1100 mm  
1 x tube angle piece 90° for rectangular shower tray  
2 x 10 shower curtain rings, white

as desired, also available with shower curtain PLAN maxx white

as desired, also available with shower curtain PLAN maxx white



**Tube angle piece 90°**  
for quarter-circle shower tray

**Shower curtain PLAN\***  
all sizes custom-made  
Please indicate: materials, colours, full length and width



**Curtain ring**  
in black or white

**Wall mounting set**  
with cover, for slanted ceilings adjustable between 10 to 80 degrees



**Wall mounting set**  
with decor cover



**Ceiling support (set)**  
complete, consisting of:  
1 x wall mounting set  
1 x shower curtain rail  
1 x connecting piece  
300 – 800 mm



Product Overview

- surface chrome-plated
- surface aluminium silver anodized (E6 EV1) or aluminium finish
- surface stainless steel or stainless steel finish



**Set of shower curtain rails**  
for rectangular shower tray 1000 x 1000 mm, consisting of:  
2 x wall mounting set  
2 x shower curtain rail 900 mm  
1 x shower curtain rail 800 mm  
2 x tube angle piece 90° for rectangular shower tray  
3 x 10 shower curtain rings, white

as desired, also available with 2 shower curtains PLAN maxx white



**Set of shower curtain rails**  
for rectangular shower tray 1200 x 1200 mm, consisting of:  
2 x wall mounting set  
2 x shower curtain rail 1100 mm  
1 x shower curtain rail 1000 mm  
2 x tube angle piece 90° for rectangular shower tray  
3 x 10 shower curtain rings, white

as desired, also available with 2 shower curtains PLAN maxx white



**Set of shower curtain rails**  
for rectangular shower tray 800 x 800 mm, consisting of:  
3 x wall mounting set  
2 x shower curtain rail 700 mm  
1 x tube angle piece 90° for rectangular shower tray  
1 x ceiling support 400 mm  
1 x connecting piece  
2 x 10 shower curtain rings, white

as desired, also available with shower curtain PLAN uni white





**Set of shower curtain rails**  
for rectangular shower tray 900 x 900 mm, consisting of:  
3 x wall mounting set  
2 x shower curtain rail 800 mm  
1 x tube angle piece 90° for rectangular shower tray  
1 x ceiling support 400 mm  
1 x connecting piece  
2 x 10 shower curtain rings, white

as desired, also available with shower curtain PLAN uni white



**Set of shower curtain rails**  
for quarter-circle shower tray 900 x 900 mm, consisting of:  
3 x wall mounting set  
2 x shower curtain rail 300 mm  
1 x tube angle piece for quarter-circle shower tray  
1 x ceiling support 400 mm  
1 x connecting piece  
2 x 10 shower curtain rings, white

as desired, also available with shower curtain PLAN uni white

 surface chrome-plated
  surface aluminium silver anodized (E6 EV1) or aluminium finish
  surface stainless steel or stainless steel finish



**Single lever basin mixer**  
with/without pop-up waste, 1-hole installation, ceramic cartridge with temperature limiter



**Single lever basin mixer**  
with/without pop-up waste, for open hot water heater, 1-hole installation, ceramic cartridge with temperature limiter



**Single lever basin mixer**  
without pop-up waste, middle size model, 1-hole installation, ceramic cartridge with temperature limiter



**Wall bracket for hand shower**  
for shower hoses with conical nuts



**Wall bracket for shower hose**  
suitable for all in wall fittings



**Infrared basin mixer**  
with/without pop-up waste, 1-hole installation, modular monoblock without base, infrared sensor (automatic settings), adjustable flow timer (battery 6 V lithium DL 223 A)



**Infrared basin mixer**  
without pop-up waste, 1-hole installation, modular monoblock without base, infrared sensor (automatic settings), adjustable flow timer (mains operation 230 V)



**Pillar tap**  
without pop-up waste, 1-hole installation, 90° head part with ceramic sealing gaskets



**Hand shower**  
with anti-calcification system, functions:  
• Normal jet  
• Soft jet  
• Massage jet



**Hand shower sliding rail**  
consisting of:  
• Wall rail, 800 mm  
• Sliding bracket for hand shower  
• Tile compensation plate

Product Overview



**Single lever bidet mixer**  
with pop-up waste, 1-hole installation, ceramic cartridge with temperature limiter

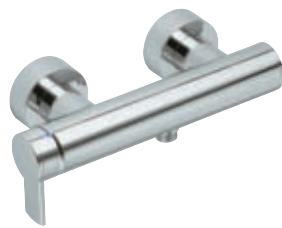

**Single lever shower mixer**  
for on wall mounting, ceramic cartridge with temperature limiter



**Single lever shower mixer**  
for in wall mounting, complete set matches Flexx Boxx EHM DN 20, consisting of: lever, sleeve and collar



**Thermostat battery**  
for in wall mounting, with ceramic cut-off valve, complete set matches Flexx Boxx THM DN 20, consisting of: lever, sleeve and collar



**Shower hose**  
1250, 1600, 2000 mm



**Single lever bath tub mixer**  
for on wall mounting, ceramic cartridge with temperature limiter, with automatic return bath tub/shower



**Thermostat battery for shower**  
for on wall mounting, handle with 50% quantity limiter, safety cut-off at 38 °C, intrinsically safe against backflow



**Single lever bath tub mixer**  
for in wall mounting, complete set matches Flexx Boxx EHM DN 20, consisting of: lever, sleeve adjuster and collar



**Thermostat battery**  
for in wall mounting, with ceramic stop and switch cock, complete set matches Flexx Boxx THM DN 20, consisting of: lever, sleeve and collar



**Bath filler**  
suitable for all in wall fittings  
Projection: 135, 185 mm



**Towel rail**  
400, 600, 800, 1000 mm



**Shelf**  
with crystal or crystalline glass shelf  
360 x 131 x 10 mm  
600 x 131 x 10 mm  
700 x 131 x 10 mm  
950 x 131 x 10 mm



**Towel hook** 34 mm  
**Towel hook** 59 mm  
**Robe hook** 82 mm

surface  
chrome-plated



**Towel rack**  
620 mm



**Sponge basket for corner installation**  
with detachable insert



**Bathroom stool**  
chrome-plated/walnut veneer

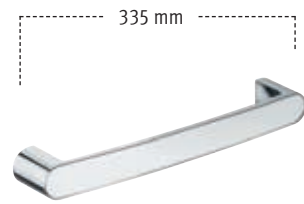

**Towel rail**  
300 mm

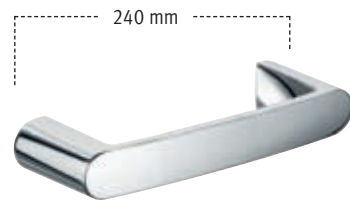

**Towel ring**  
205 mm



**Towel hook**  
double



**Towel holder**  
two arms, swivelling  
Projection: 450, 340 mm



**Cosmetic mirror**  
Wall model, illuminated,  
optional with mains connection  
or helix cable and power plug,  
magnification factor x 5,  
1 x 8 W energy efficient lamp, Ø 207 mm



**Sponge basket**  
with detachable insert

Product Overview



**Soap holder**  
with frosted crystal glass dish



**Tumbler holder**  
with frosted crystal glass tumbler



**Lotion dispenser**  
with frosted crystal glass  
for liquid soap  
Capacity: approx. 180 ml

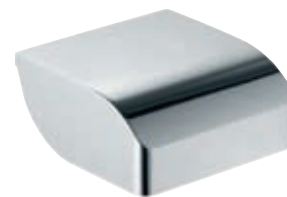

**Toilet paper holder**  
with lid, for 100/120 mm wide paper rolls



**Spare paper holder**

**Toilet brush set**  
complete with frosted crystal glass insert,  
brush and spare brush head

**Foamed-soap dispenser**  
with frosted opal glass  
Capacity: approx. 220 ml  
including starter materials  
foam-soap (2 x 500 ml)



**Foamed-soap dispenser**  
for mounting on wash-basin or wash-basin worktop,  
including starter materials foam-soap (2 x 500 ml)  
Capacity: approx. 500 ml  
Height: 93, 161 mm



**Toilet paper holder**  
open form, for 100/120 mm wide paper rolls



**Toilet brush set**  
with lid, synthetic insert, brush  
and spare brush head



surface  
chrome-plated



**Crystal mirror**  
with all round faced cut  
360 x 635 mm  
700 x 750 mm  
950 x 635 mm

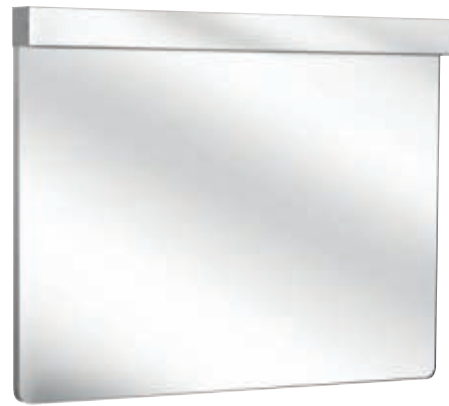

**Light mirror**  
horizontal illumination, mirrored front panel, both task lighting and moodlight, switched separately with concealed switches, fluorescent lamps (2 x 14 W T5)/700 x 820 x 66 mm (2 x 21 W T5)/950 x 705 x 66 mm



**Light mirror**  
horizontal illumination, mirrored front panel, both task lighting and moodlight, switched separately with concealed switches, fluorescent lamp (1 x 24 W)  
360 x 705 x 66 mm



**Single lever wash-basin mixer**  
large model  
with/without pop-up waste, 1-hole installation, cartridge mixer with ceramic sealing gaskets



**Single lever wash-basin mixer**  
with/without pop-up waste, 1-hole installation, cartridge mixer with ceramic sealing gaskets



**Extension to single lever wash-basin mixer**  
matches single lever wash-basin mixer 51602, 51604 and 51608  
Height: 90 mm

Please note: Single lever wash-basin mixer to be ordered separately!



**Single lever bidet mixer**  
with pop-up waste, 1-hole installation, cartridge mixer with ceramic sealing gaskets



**Pillar tap**  
without pop-up waste  
1-hole installation, 90° head part with ceramic sealing gaskets

Product Overview



**Wall light**  
optional for horizontal or vertical installation, mirrored front panel, both task lighting and moodlight, switched separately via room switch, fluorescent lamps (2 x 14 W T5)/700 x 70 x 66 mm (2 x 21 W T5)/950 x 70 x 66 mm

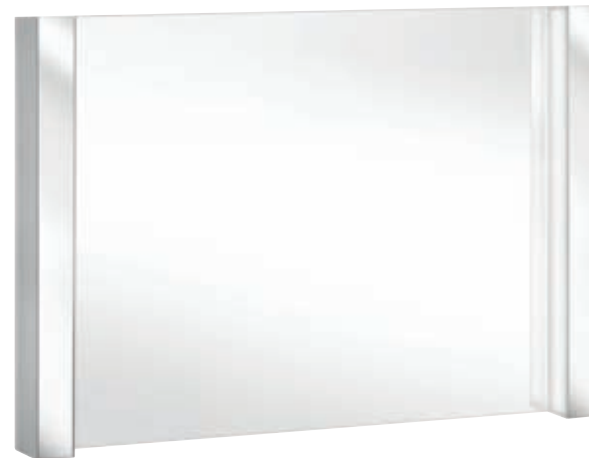

**Light mirror**  
vertical illumination, mirrored front panel, both task lighting and moodlight, switched separately with concealed switches, fluorescent lamps (4 x 14 W T5)  
700 x 635 x 66 mm  
950 x 635 x 66 mm



**Design bottle trap**  
G 1 ¼ inches, telescopic inlet tube 140 mm, wall tube 330 mm, rosette Ø 72 mm



**Bath filler**  
suitable for all in wall fittings  
Projection: 146, 196 mm



**Single lever bath tub and shower mixer**  
4-hole bath deck-mounted, cartridge mixer with ceramic sealing gaskets, with automatic return bath tub/shower, concealable hand shower with normal-, soft-, and massage jet

surface  
chrome-plated

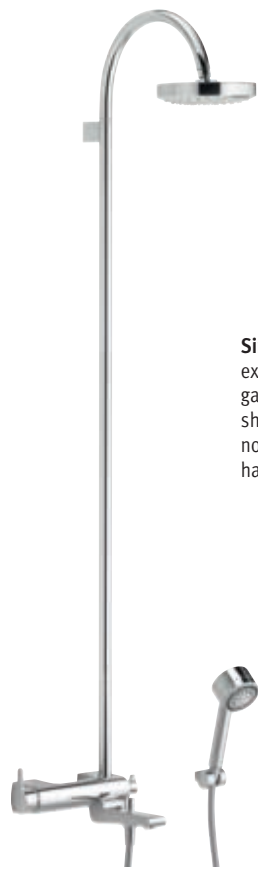

**Single lever bath tub mixer with head shower**  
exposed fitting, cartridge mixer with ceramic sealing gaskets, with automatic return bath tub/shower, head shower swivelling, Ø 180 mm, hand shower with normal-, soft-, and massage jet, with sliding bracket for hand shower and shower hose (2000 mm)



**Single lever bath shower mixer with head shower**  
exposed fitting, cartridge mixer with ceramic sealing gaskets, head shower swivelling, Ø 180 mm, hand shower with normal-, soft-, and massage jet, with sliding bracket for hand shower and shower hose (1600 mm)



**Hand shower sliding rail**  
consisting of:  
• Wall rail 900 mm  
• Sliding bracket for shower head  
• Tile compensation plate



**Hand shower**  
with anti-calcification system:  
• Normal jet  
• Soft jet  
• Massage jet

**Shower hose**  
1250, 1600, 2000 mm



**Wall bracket for shower hose**  
for shower hoses with conical nuts

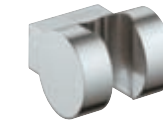

**Wall bracket for shower hose**  
suitable for all in wall fittings



Product Overview



**Thermostat battery with head shower**  
exposed fitting, handle with 50% quantity limiter safety cut-off at 38°, intrinsically safe against backflow, head shower swivelling, Ø 180 mm, hand shower with normal-, soft-, and massage jet, with sliding bracket for hand shower and shower hose (1600 mm)

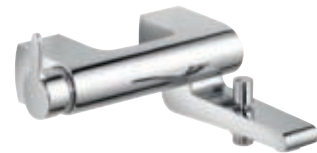

**Single lever bath tub mixer**  
exposed fitting, cartridge mixer with ceramic sealing gaskets, with automatic return bath tub/shower



**Single lever shower mixer**  
exposed fitting, cartridge mixer with ceramic sealing gaskets



**Head shower**  
Ø 180 mm, with shower head rail  
Projection: 300, 450 mm



**Thermostat battery for shower**  
exposed fitting, handle with 50% quantity limiter safety cut-off at 38°, intrinsically safe against backflow



**Single lever shower mixer**  
concealed fitting, complete set matches Flexx Boxx EHM DN 20 consisting of: lever, sleeve and collar



**Thermostat battery**  
concealed fitting, with shut-off valve, complete set matches Flexx Boxx THM DN 20 consisting of: lever, sleeve and collar



**Single lever bath tub mixer**  
concealed fitting, complete set matches Flexx Boxx EHM DN 20 consisting of: lever, sleeve, adjuster and collar



**Thermostat battery**  
concealed fitting, with shut-off valve and diverter, complete set matches Flexx Boxx THM DN 20 consisting of: lever, sleeve, adjuster and collar

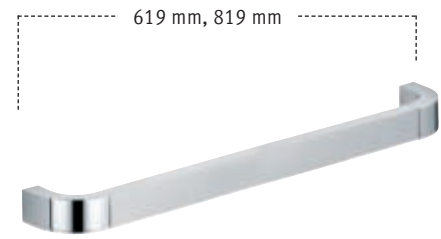

**Towel rail**  
600, 800 mm



**Shelf**  
with crystalline glass shelf  
650 x 120 mm  
950 x 120 mm  
1250 x 120 mm



**Towel hook**  
double



**Towel ring**  
Ø 210 mm  
Projection: 212 mm

surface  
chrome-plated



**Single lever basin mixer**  
with/without pop-up waste, 1-hole installation,  
ceramic cartridge with temperature limiter



**Single lever basin mixer**  
with extended spout, with/without pop-up waste,  
1-hole installation, ceramic cartridge with  
temperature limiter



**Single lever basin mixer**  
with reduced spout height, without pop-up waste,  
1-hole installation, ceramic cartridge with  
temperature limiter

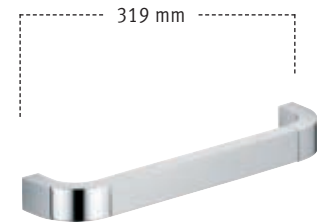

**Towel rail**  
300 mm



**Towel holder**  
fixed  
Projection: 465, 320 mm



**Towel holder**  
holds 6 guest towels  
(approx. 30 x 50 cm)  
Height: 465 mm



**Toilet brush set**  
with frosted crystal glass  
insert and brush



**Single lever basin mixer**  
for on wall mounting, ceramic cartridge  
with temperature limiter



**Single lever basin mixer**  
for on wall mounting, matching  
mirror/light mirror Ø 950 mm,  
ceramic cartridge with temperature limiter



**Single lever basin mixer**  
for in wall mounting, ceramic cartridge  
with temperature limiter

Product Overview



**Toilet paper holder**  
with lid



**Spare paper holder**



**Wall light**  
with opal glass matt  
(1 x 40 W)



**Single lever basin mixer**  
for in wall mounting, ceramic cartridge  
with temperature limiter



**Two handle basin mixer**  
with/without pop-up waste, 1-hole installation,  
90° head parts with ceramic sealing gaskets



**Three-hole basin mixer**  
Model with plate,  
depth gauge 200 mm with/without pop-up waste,  
depth gauge 300 mm with pop-up waste,  
3-hole installation, 90° head parts with ceramic  
sealing gaskets



**Tumbler holder**  
with frosted crystal glass tumbler



**Lotion dispenser**  
with frosted crystal glass  
Capacity: approx. 180 ml



**Soap holder**  
with frosted crystal glass dish



**Three-hole basin mixer**  
Model with collars,  
with/without pop-up waste, 3-hole installation,  
90° head parts with ceramic sealing gaskets



**Single lever bidet mixer**  
with pop-up waste, 1-hole installation,  
ceramic cartridge with temperature limiter



**Two handle bidet mixer**  
with pop-up waste, 1-hole installation,  
90° head parts with ceramic sealing gaskets



**Two handle shower mixer**  
for on wall mounting,  
90° head parts with ceramic sealing gaskets



**Single lever shower mixer**  
for in wall mounting,  
complete set matches Flexx Boxx EHM DN 20,  
consisting of: lever, sleeve, collar



**Two handle bath tub mixer**  
for on wall mounting,  
90° headparts with ceramic sealing gaskets,  
with automatic return bath tub/shower



**Single lever bath tub mixer**  
for in wall mounting,  
complete set matches Flexx Boxx EHM DN 20,  
consisting of: lever, sleeve, adjuster and collar



**Single lever shower mixer**  
for on wall mounting,  
ceramic cartridge with temperature limiter



**Single lever shower mixer**  
for in wall mounting,  
complete set matches Flexx Boxx EHM DN 20,  
consisting of: lever sleeve and collar

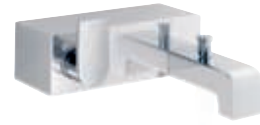

**Single lever bath tub mixer**  
for on wall mounting,  
ceramic cartridge with temperature limiter  
with automatic return bath tub/shower



**Single lever bath tub mixer**  
for in wall mounting,  
complete set matches Flexx Boxx EHM DN 20,  
consisting of: lever, sleeve, adjuster and collar



**Single lever bath tub and shower mixer**  
4-hole bath tub edge installation,  
ceramic cartridge with temperature limiter,  
with automatic return bath tub/shower,  
concealable hand shower



**Bath filler**  
suitable for all in wall fittings,  
as desired with round or rectangular decor disc  
Projection: 150, 200 mm

Product Overview



**Hand shower sliding rail**  
consisting of:  
• Wall rail, 800 mm  
• Sliding bracket for hand shower  
• Tile compensation plate



**Wall bracket for hand shower**  
for shower hoses with conical nuts



**Shower hose**  
1250, 1600, 2000 mm



**Wall bracket for shower hose**  
suitable for all in wall fittings,  
as desired with round or rectangular decor disc



**Hand shower**  
with anti-calcification system,  
functions:  
• Normal jet  
• Soft jet  
• Massage jet



**Thermostat battery**  
for in wall mounting,  
with ceramic stop and switch cock,  
complete set matches Flexx Boxx THM DN 20,  
consisting of: lever, sleeve and collar



**Thermostat battery**  
for in wall mounting,  
with ceramic stop cock,  
complete set matches Flexx Boxx THM DN 20,  
consisting of: lever, sleeve and collar



**Thermostat battery**  
for in wall mounting,  
with ceramic stop and switch cock,  
complete set matches Flexx Boxx THM DN 20,  
consisting of: lever, sleeve and collar



**Thermostat battery**  
for in wall mounting,  
with ceramic stop cock,  
complete set matches Flexx Boxx THM DN 20,  
consisting of: lever, sleeve and collar



**Head shower**  
with shower head rail  
Projection: 300, 450 mm





**Towel rail**  
600, 800 mm



**Towel rail**  
300 mm



**Towel ring**



**Shelf bracket**  
without shelf  
700, 950 mm

**Crystalline glass shelf**  
Shelf only, without green tinged edge,  
under-surface lacquered white, black or cream  
700 x 135 mm  
950 x 135 mm

**Please note: Bracket and glass plate are ordered separately.**



**Towel holder**  
two arms, swivelling  
Projection: 457 mm

 surface chrome-plated
  surface palladium silver

**Towel hook**  
double



**Cosmetic mirror**  
Wall model, illuminated,  
with main connection through wall socket,  
magnification factor x 3, 1 x 8 W LED  
Ø 218 mm



**Moisture box**  
with white porcelain box



**Toilet paper holder**  
with lid, for 100/120 mm wide paper rolls



**Kleenex box**  
with closed sides, for up to max. 150 sheets



**Toilet brush set**  
with lid, synthetic insert,  
brush with handle and spare brush head



**Tumbler holder**  
complete with white porcelain tumbler

**Spare paper holder**



**Soap holder**  
complete with white porcelain dish



**Lotion dispenser**  
Porcelain white, complete with holder and pump  
Capacity: approx. 250 ml

Product Overview



**Single lever basin mixer**  
with/without pop-up waste, 1-hole installation,  
ceramic cartridge with temperature limiter



**Three-hole basin mixer**  
with/without pop-up waste, 3-hole installation,  
90° head parts with ceramic sealing gaskets



**Single lever bidet mixer**  
with pop-up waste, 1-hole installation,  
ceramic cartridge with temperature limiter



**Bath filler**  
suitable for all in wall fittings  
Projection: 162, 212 mm



**Sponge basket for corner installation**  
made of porcelain, white



**Wall bracket for shower hose**  
suitable for all in wall fittings



**Thermostat battery for shower**  
for on wall mounting, handle with 50% quantity  
limiter, safety cut-off at 38 °C, intrinsic protection  
against backflow



**Thermostat battery**  
for in wall mounting, with ceramic stop cock,  
complete set matches Flexx Boxx THM DN 20,  
consisting of: lever, sleeve and collar



**Thermostat battery**  
for in wall mounting, with ceramic stop and switch cock,  
complete set matches Flexx Boxx THM DN 20,  
consisting of: lever, sleeve and collar



**Two handle bath tub mixer**  
for on wall mounting,  
90° head parts with ceramic sealing gaskets,  
with automatic return bath tub/shower



**Wall bracket for hand shower**  
for shower heads with conical nuts

**Hand shower**  
with anti-calcification system  
Functions:  
• Rain jet  
• Needle jet  
• Massage jet



**Shower hose**  
1250, 1600, 2000 mm

**Hand shower sliding rail**  
consisting of:  
• Wall rail, 900 mm  
• Sliding bracket for hand shower  
• Tile compensation plate



 surface  
chrome-plated



**Floor lamp**  
with lamp shade made of  
chintz, washable, rocket  
switch, connecting cable  
2.50 m long  
(for 3 x 60 W/E27 matt)  
Ø shade: 500 mm  
Height: 1825 mm

**Tray**  
made of porcelain  
Ø 415 mm  
Height: 70 mm



**Side table**  
Top made of porcelain  
Ø 415 mm, Height: 710 mm

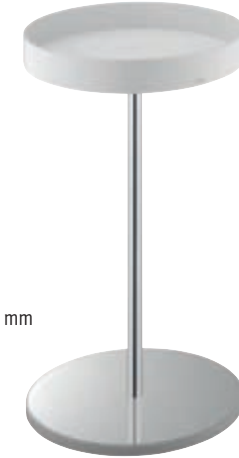

**Bath towel rail, floor model**  
Width: 800 mm  
Height: 850 mm



**Wash-basin fitting, free-standing**  
mixing technology with ceramic sealing gaskets,  
for free-standing mounting, without pop-up waste  
Projection: 250 mm, Height: 700 mm



**Single lever bath tub mixer**  
for free-standing mounting,  
cartridge mixer with ceramic  
sealing gaskets and temperature  
limiter, complete with hand held  
rod shower head and shower hose  
1250 mm



**Hand held  
rod shower head**  
with normal jet



**Shower unit**  
consisting of:  
• Disk shower head with rain jet  
or  
• Shower head with aerator jet  
• Hand held rod shower head  
• Shower hose 1600 mm  
• Shower bracket with adjustable  
tilt angle

Product Overview

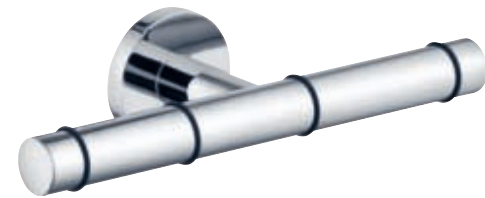

**Toilet paper double holder**  
for 100/120 mm wide paper rolls



**Stacking accessories**  
consisting of:  
• 3 containers with  
synthetic insert  
• 1 cover/dish  
Ø 103 mm  
Height: 320 mm (stacked)

**Soap foam dispenser**  
standing model,  
with synthetic insert and pump,  
including starter materials  
foam-soap (2 x 500 ml)  
Capacity: approx. 150 ml



**Toilet brush set**  
standing model, complete  
with glass insert, brush and  
spare brush head



**Thermostat battery**  
for in wall mounting, with ceramic stop and switch  
cock, complete set matches Flexx Boxx THM DN 20,  
consisting of: lever, sleeve and collar



**Single lever bath tub mixer**  
for in wall mounting,  
complete set matches Flexx Boxx EHM DN 20,  
consisting of: lever, sleeve adjuster and collar

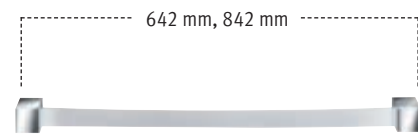

**Towel rail**  
600, 800 mm



**Shelf**  
with crystalline glass shelf, underside matt  
450 x 120 mm  
650 x 120 mm

surface  
chrome-plated



**Toilet brush set**  
complete with synthetic insert, brush  
and spare brush head, mountable with  
opening on right or left



**Spare paper holder**



**Toilet paper holder**  
open form  
mountable with opening on right or left



**Towel rail**  
300 mm



**Towel hook panel**



**Towel hook  
double**

Product Overview



**Towel holder**  
one arm, swivelling  
Projection: 420 mm



**Towel ring**  
as desired mountable with opening on right or left

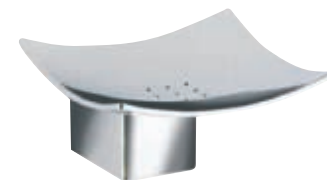

**Soap holder**  
complete with soap dish metal finish



**Tumbler holder**  
complete with frosted crystal glass tumbler



**Lotion dispenser**  
with frosted crystal glass,  
Capacity: approx. 170 ml



**Wall light**  
with diffuser, frosted opal glass  
(1 x 60 W)

 surface chrome-plated
  surface bicolour chrome-plated/gold-plated

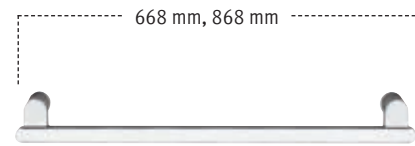

**Towel rail**  
600, 800 mm



**Shelf**  
with crystalline glass shelf  
450 x 130 mm  
650 x 130 mm



**Towel hook**



**Towel hook double**



**Soap holder**  
right or left-hand model,  
with crystal glass dish

**Toilet paper holder**  
open form



**Toilet paper holder**  
with lid, for 100/120 mm  
wide paper rolls



**Towel rail**  
300 mm



**Towel ring**



**Robe hook**



**Towel holder**  
two arms, swivelling  
Projection: 448, 300 mm



**Lotion dispenser**  
right or left-hand model,  
with frosted opal glass  
Capacity: approx. 160 ml



**Tumbler holder**  
right or left-hand model,  
with crystal glass tumbler



**Double tumbler holder**  
with crystal glass tumblers



**Spare paper holder**

Product Overview



**Universal dish**  
with rail and crystalline glass shelf



**Cosmetic mirror**  
on wall rail, illuminated,  
adjustable in three dimensions,  
magnification factor x 2.5  
Ø 230 mm



**Wall light**  
small model,  
frosted opal glass,  
with halogen bulb  
(1 x 60 W E14)



**Wall light**  
large model,  
frosted opal glass,  
with halogen bulb  
(1 x 60 W E14)



**Decor set no. 02**  
chrome-plated, velour chrome,  
gold-plated

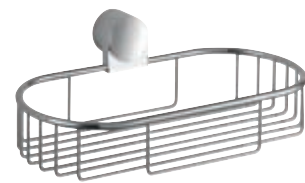

**Sponge wire basket**



**Cosmetic mirror**  
on wall rail, illuminated,  
adjustable in three dimensions,  
magnification factor x 2.5,  
1 x 7 W G 23  
Ø 260 mm



**Ceiling light**  
with frosted opal glass and metal fixture  
(1 x 75 W E27)



**Toilet brush set**  
with synthetic insert or crystal glass insert,  
brush and spare brush head



**Toilet brush set**  
with lid, complete with brush and spare brush head



**Guest towel basket**

 surface chrome-plated
  surface bicolour chrome-plated/gold-plated



**Towel rail**  
600, 800 mm



**Shelf**  
with crystalline glass shelf  
450 x 120 mm  
650 x 120 mm



**Towel hook**



**Robe hook**



**Toilet paper holder**  
with lid



**Towel rack**  
Width: 650 mm



**Spare paper holder**



**Towel rail**  
300 mm



**Towel holder**  
one arm, fixed  
Projection: 434 mm

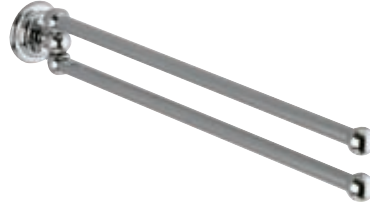

**Towel holder**  
two arms, swivelling  
Projection: 465 mm



**Toilet brush set**  
complete with frosted crystal glass insert and brush



**Toilet brush set**  
with lid, complete with brush and spare brush head

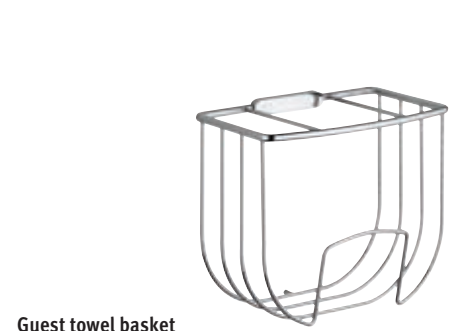

**Guest towel basket**

Product Overview

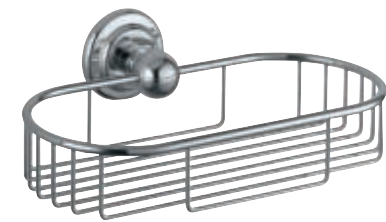

**Sponge wire basket**



**Towel ring**  
Ø 175 mm



**Tumbler holder**  
with crystal glass tumbler



**Wall decor disk**  
chrome-plated, gold-plated



**Wall decor disk**  
to wall light ASTOR  
chrome-plated, gold-plated



**Cosmetic mirror**  
on wall rail, non illuminated,  
adjustable in three dimensions,  
magnification factor x 2.5  
Ø 230 mm



**Cosmetic mirror**  
on wall rail, illuminated,  
adjustable in three dimensions,  
magnification factor x 2.5, 1 x 7 W G 23  
Ø 260 mm



**Lotion dispenser**  
with frosted opal glass  
Capacity: approx. 160 ml



**Lotion dispenser**  
with frosted opal glass  
Capacity: approx. 160 ml



**Soap holder**  
with crystal soap dish



**Ceiling light**  
with frosted opal glass and metal fixture  
(1 x 75 W E27)



**Wall light**  
with frosted opal glass (1 x 40 W E14)

surface  
chrome-plated



**Towel rail**  
400, 600, 800 mm



**Shelf**  
with crystal glass shelf  
450 x 120 mm  
650 x 120 mm



**Towel hook**



**Toilet paper holder**  
with lid



**Toilet paper holder**  
open form



**Towel rail**  
double  
600 mm



**Towel rail**  
250 mm



**Towel hook**  
double



**Spare paper holder**



**Toilet brush set**  
with synthetic insert, brush  
and spare brush head

Product Overview

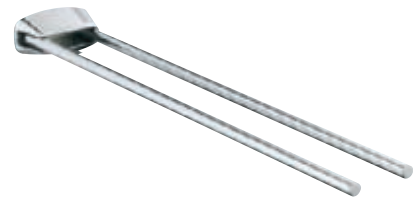

**Towel holder**  
two arms, swivelling  
Projection: 430 mm



**Towel ring**  
Ø 192 mm



**Tumbler holder**  
with crystal or acrylic glass tumbler



**Double tumbler holder**  
with crystal or acrylic glass tumblers



**Lotion dispenser**  
with frosted crystal glass  
Capacity: approx. 250 ml



**Soap holder**  
with crystal or acrylic soap dish

 surface chrome-plated
  surface bicolour chrome-plated/gold-plated

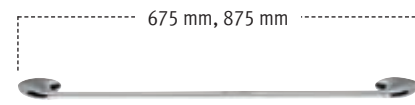

**Towel rail**  
600, 800 mm



**Shelf**  
with crystalline glass shelf  
450 x 120 mm  
650 x 140 mm



**Towel hook**



**Toilet paper holder**  
with lid, for 100/120 mm  
wide paper rolls



**Spare paper holder**



**Decor/mounting element**  
to towel hook CLEO  
chrome-plated, gold-plated



**Towel rail**  
300 mm



**Towel hook**  
double



**Robe hook**



**Toilet brush set**  
with lid, complete with brush  
and spare brush head



**Toilet paper holder**  
open form



**Wall decor disk**  
chrome-plated, gold-plated

Product Overview



**Towel holder**  
two arms, swivelling  
Projection: 460 mm



**Towel ring**  
as desired, opening on right or left



**Tumbler holder**  
complete with crystal glass



**Lotion dispenser**  
with frosted opal glass  
Capacity: approx. 160 ml



**Soap holder**  
fixed, made of metal



**Soap holder**  
complete with crystal soap dish

surface  
chrome-plated



**Towel rail**  
600, 800 mm

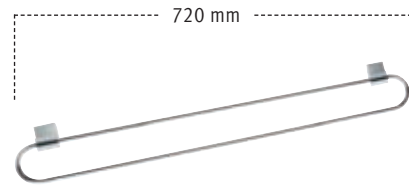

**Towel rail**  
double  
600 mm



**Shelf**  
with crystalline glass shelf, underside matt  
430 x 130 mm  
550 x 130 mm  
800 x 130 mm  
1000 x 130 mm



**Towel hook**  
double

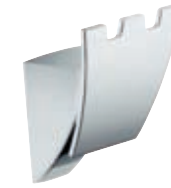

**Towel hook**  
with 3 hooks

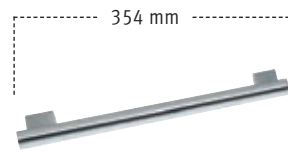

**Towel rail**  
300 mm



**Towel holder**  
two arms, fixed  
Projection: 466 mm



**Towel ring**



**Soap holder**  
with frosted crystal soap dish



**Tumbler holder**  
with crystal glass tumbler



**Lotion dispenser**  
frosted opal glass  
Capacity: approx. 200 ml

Product Overview



**Toilet brush set**  
with frosted crystal glass insert,  
brush and spare brush head



**Toilet paper holder**  
with lid



**Spare paper holder**



**Cosmetic mirror**  
on wall rail, non illuminated, adjustable in three  
dimensions, magnification factor x 2.5  
Ø 230 mm

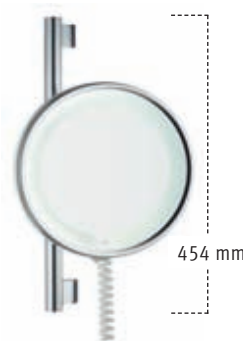

**Cosmetic mirror**  
on wall rail, illuminated, adjustable in three  
dimensions, magnification factor x 2.5, 1 x 7 W G 23  
Ø 260 mm

**Wall light**  
small model, with frosted opal glass  
(1 x 24 W)



**Wall light**  
large model, with frosted opal glass  
(1 x 36 W)

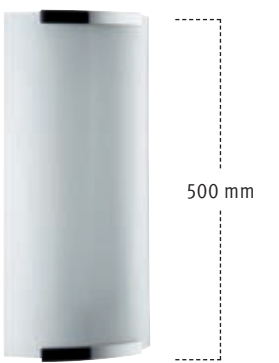



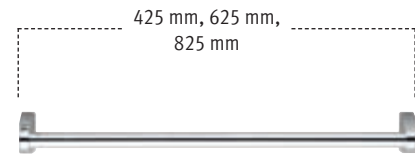

**Towel rail**  
400, 600, 800 mm



**Shelf**  
with crystal glass shelf  
450 x 120 mm  
550 x 120 mm



**Towel hook**

surface  
chrome-plated



**Toilet paper holder**  
with lid

**Spare paper holder**



**Wall light**  
with frosted opal glass  
(1 x 60 W E27)

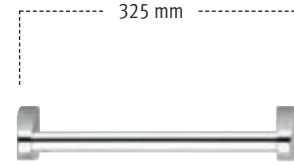

**Towel rail**  
300 mm



**Towel hook**



**Towel holder**  
two arms, swivelling  
Projection: 461 mm

**Toilet brush set**  
complete, with opaque synthetic  
insert and brush



**Guest towel basket**



**Wall light**  
rotating and swivelling, with frosted opal glass  
halogen bulb for mains voltage (1 x 60 W B15d)



Product Overview



**Towel ring**  
Ø 192 mm



**Lotion dispenser**  
frosted opaque synthetic  
Capacity: approx. 300 ml



**Lotion dispenser**  
frosted opal glass  
Capacity: approx. 160 ml



**Soap holder**  
complete with crystal soap dish



**Soap holder**  
complete with crystal soap dish



**Soap holder**  
complete with acrylic soap dish



**Tumbler holder**  
complete with crystal glass tumbler



**Tumbler holder**  
complete with crystal glass tumbler



**Double tumbler holder**  
complete with crystal glass tumblers

**Cosmetic mirror**  
on wall rail, illuminated,  
adjustable in three dimensions,  
magnification factor x 2.5  
Ø 230 mm



**Cosmetic mirror**  
on wall rail, illuminated,  
adjustable in three dimensions,  
magnification factor x 2.5, 1 x 7 W G 23  
Ø 260 mm





**Towel rail**  
with soap holder and drainage slots



**Wall shelf**  
with crystal or crystalline glass shelf  
350 x 120 mm  
450 x 120 mm  
650 x 120 mm



**Corner shelf**  
with crystal glass shelf  
Side length: 250 mm

surface  
chrome-plated



**Towel rack**  
620 mm

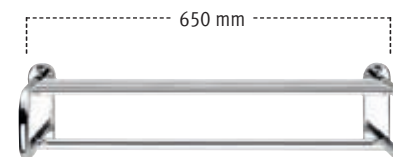

**Towel rack**  
600 mm

## Universal articles



**Moisture box**  
with white porcelain box



**Towel holder**  
telescopic  
Projection: 370 – 570 mm



**Towel ring**  
two arms, swivelling



**Lotion dispenser**  
Capacity: approx. 300 ml  
also lockable available



**Spare paper holder**



**Guest towel basket**



**Doorplate**  
Symbol Ladies

**Doorplate**  
Symbol Gents

**Doorplate**  
Symbol Disabled

**Doorplate**  
Symbol Ladies/Gents

## Product Overview



**Built in soap dispenser**  
for mounting on washbasin  
or washbasin worktop



**Lotion dispenser, table model**  
Capacity: approx. 250 ml



**Lotion dispenser, standing model**  
Capacity: approx. 250 ml



**Soap foam dispenser, table model**  
Capacity: approx. 250 ml

**Soap foam dispenser**  
standing model,  
with synthetic insert and pump,  
including starter materials  
foam-soap (2 x 500 ml)  
Capacity: approx. 150 ml



**Foamed-soap dispenser**  
for mounting on wash-basin or wash-basin worktop,  
including starter materials foam-soap (2 x 500 ml)  
Capacity: approx. 500 ml  
Height: 93, 161 mm



**Hygiene bag dispenser**  
ABS plastic for max. 25 bags  
including first 25 bags



**Clothes line**  
complete with wall mounting element  
extendable up to max. 2.80 m



**Kleenex box**  
with closed sides, for up to max. 150 sheets



**Kleenex box**  
with closed sides for up to max. 150 sheets

surface  
chrome-plated

# Universal articles & Soap baskets



**Hair dryer holder**  
left hand



**Hair dryer holder**  
right hand



**Bathroom stool**  
also suitable for wet rooms

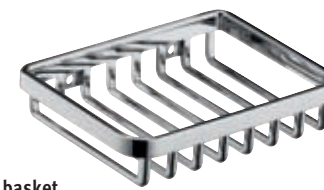

**Soap wire basket**  
132 x 100 x 28 mm

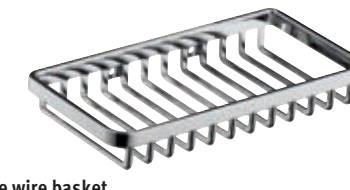

**Sponge wire basket**  
200 x 100 x 28 mm



**Soap wire basket for corner installation**  
Side length: 127 mm  
180 x 115 x 28 mm

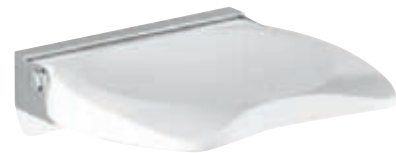

**Tip-up seat**  
with Keucolit-seat, white

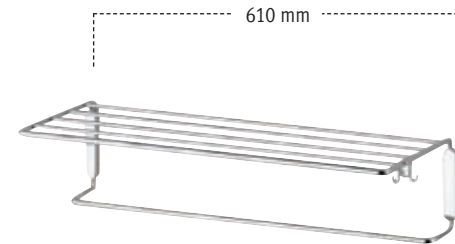

**Towel rack**  
3 pronged, complete with towel hook

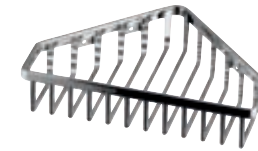

**Sponge basket for corner installation**  
Side length: 170 mm  
240 x 170 x 50 mm



**Soap wire basket**  
removable, with concealed fastening screws  
132 x 105 x 28 mm



**Sponge wire basket**  
removable, with concealed fastening screws  
200 x 114 x 28 mm

## Product Overview



**Waste bin**  
with detachable black insert  
Capacity: 5 l



**Hair dryer**  
with wall mounting element, 230 V  
Features:  
• Line disconnecter with indicator light on the wall holder  
• 3 heating levels up to max. 1800 W  
• 2 speed levels  
• Cold air button  
• Overheating protection



**Sponge basket for corner installation**  
with detachable insert



**Sponge basket**  
with detachable insert



**Sponge wire basket**  
removable, with concealed fastening screws  
200 x 114 x 70 mm



**Soap wire basket for corner installation**  
removable, with concealed fastening screws  
Side length: 140 mm  
197 x 133 x 28 mm



**Sponge basket for corner installation**  
removable, with concealed fastening screws  
Side length: 186 mm  
260 x 180 x 72 mm



**Sponge basket for corner installation**  
removable, with concealed fastening screws  
Side length: 186 mm  
264 x 180 x 47 mm

# Cosmetic mirrors



max.  
365 mm

**Cosmetic mirror**  
on double jointed arm, non illuminated,  
adjustable in three dimensions,  
magnification factor x 2.5  
Ø 230 mm

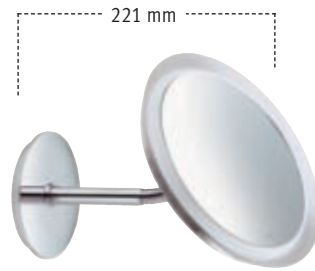

221 mm

**Cosmetic mirror BELLA VISTA**  
Wall model, illuminated,  
optional with mains connection  
or helix cable and power plug,  
magnification factor x 3, 1 x 8 W LED  
Ø 218 mm



max.  
405 mm

**Cosmetic mirror**  
on double jointed arm, illuminated,  
adjustable in three dimensions,  
magnification factor x 2.5, 1 x 7 W G 23  
Ø 260 mm



221 mm

**Cosmetic mirror BELLA VISTA**  
Standing model, illuminated,  
with power lead (1.70 m),  
magnification factor x 3, 1 x 8 W LED  
Ø 218 mm



356 mm

surface  
chrome-plated



**Cosmetic mirror PLAN**  
with pivoting arm, non illuminated,  
adjustable in three dimensions,  
magnification factor x 2.5  
Ø 190 mm



**Cosmetic mirror EDITION Palais**  
Wall model, illuminated,  
with mains connection through wall socket,  
magnification factor x 3, 1 x 8 W LED  
Ø 218 mm



460 mm

**Cosmetic mirror iLook**  
illuminated, on chrome-plated rail, vertically adjustable,  
pivotable and tiltable, power supply with adapter  
(100 to 240 V) or in-wall adapter (230 V),  
magnification factor x 3



**Cosmetic mirror ELEGANCE**  
Wall model, illuminated,  
optional with mains connection  
or helix cable and power plug,  
magnification factor x 5,  
1 x 8 W energy efficient lamp, Ø 207 mm



**Cosmetic mirror iLook**  
illuminated, 4 Mignon AA batteries necessary for  
power supply (batteries included),  
magnification factor x 3, casing colour white  
Features:  
• Chrome-plated ball-joint for wallmounting  
• Suction cup for fastening to smooth surfaces  
• Travel bag

## Product Overview



440 mm

**Cosmetic mirror AMARO**  
on wall rail, non illuminated,  
adjustable in three dimensions,  
magnification factor x 2.5  
Ø 230 mm

**Cosmetic mirror ASTOR**  
on wall rail, non illuminated,  
adjustable in three dimensions,  
magnification factor x 2.5  
Ø 230 mm

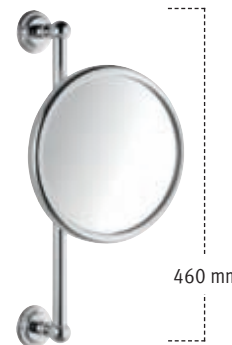

460 mm

**Cosmetic mirror EDITION 200**  
on wall rail, non illuminated,  
adjustable in three dimensions,  
magnification factor x 2.5  
Ø 230 mm



454 mm

**Cosmetic mirror SOLO**  
on wall rail, non illuminated,  
adjustable in three dimensions,  
magnification factor x 2.5  
Ø 230 mm



424 mm



440 mm

**Cosmetic mirror AMARO**  
on wall rail, illuminated,  
adjustable in three dimensions,  
magnification factor x 2.5, 1 x 7 W G 23  
Ø 260 mm

**Cosmetic mirror ASTOR**  
on wall rail, illuminated,  
adjustable in three dimensions,  
magnification factor x 2.5, 1 x 7 W G 23  
Ø 260 mm



460 mm

**Cosmetic mirror EDITION 200**  
on wall rail, illuminated,  
adjustable in three dimensions,  
magnification factor x 2.5, 1 x 7 W G 23,  
Ø 260 mm



454 mm

**Cosmetic mirror SOLO**  
on wall rail, illuminated,  
adjustable in three dimensions,  
magnification factor x 2.5, 1 x 7 W G 23  
Ø 260 mm



424 mm

surface bicolour chrome-plated

surface chrome-plated/  
stainless steel brushed (decor)

surface bicolour chrome-plated/gold-plated

surface chrome-plated



**Towel holder**  
one arm, swivelling  
Projection: 285 mm

**Toilet paper holder**  
open form  
mountable with opening on right or left

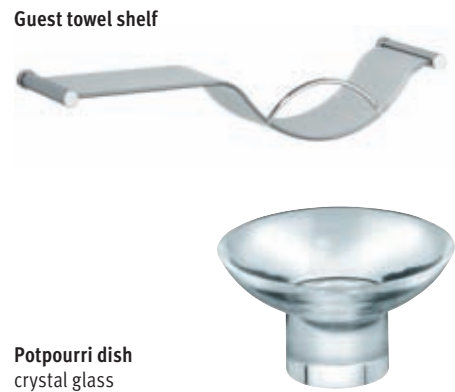

**Single lever basin mixer**  
for hand wash-basin,  
with/without pop-up waste,  
1-hole installation,  
ceramic cartridge with temperature limiter

**Pillar tap**  
for hand wash-basin,  
without pop-up waste, 1-hole installation,  
90° head part with ceramic sealing gaskets

**Potpourri dish**  
crystal glass

**Towel ring**  
mountable with opening on right or left



**Spare paper holder**

**Toilet brush set**  
with opaque synthetic insert,  
brush and spare brush head,  
mountable with opening on  
right or left



Product Overview



569 mm



462 mm

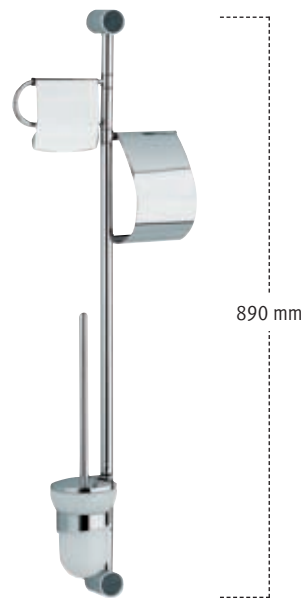

890 mm

**Set for washbasin**  
with 2 openings for soap dish, lotion dispenser  
or potpourri dish

**Set for washbasin**  
with 1 opening for soap dish, lotion dispenser  
or potpourri dish, right or left-hand model

**Toilet set**  
with toilet paper holder, spare paper holder  
and toilet brush set, right or left-hand model



**Pillar tap**  
without pop-up waste, 1-hole installation,  
90° head part with ceramic sealing gaskets,  
with integrated lotion dispenser  
320 x 165 x 40 mm

Only available together with light mirror  
(model with drawers)



**Two handle basin mixer**  
without pop-up waste, 1-hole installation,  
90° head parts with ceramic sealing gaskets,  
with integrated lotion dispenser  
320 x 165 x 40 mm

Only available together with light mirror  
(model with drawers)



**Single lever basin mixer**  
without pop-up waste, 1-hole installation,  
ceramic cartridge with temperature limiter,  
with integrated lotion dispenser  
320 x 165 x 40 mm

Only available together with light mirror  
(model without drawers)

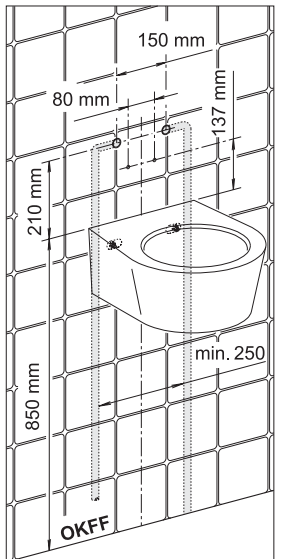

**Attention:** With the single lever basin mixer it is imperative to refer to plumbing installation instructions ([www.keuco.de](http://www.keuco.de)).